



Agilent 7890B Gas Chromatograph

**RESOLVE
YOUR SEARCH
FOR RELIABILITY**

The Measure of Confidence



Agilent Technologies

THE AGILENT 7890B GC

RESOLVE YOUR SEARCH FOR THE NEXT EVOLUTION IN GAS CHROMATOGRAPHY

Building the world's most trusted GC system is an ongoing process. With every step, we increase speed, improve functionality, and incorporate new analytical capabilities – all while never losing sight of the most important objective: *RESULTS*.

Now, Agilent has achieved a new level of GC performance and GC/MSD system integration

Agilent's flagship 7890B GC system has everything you need to boost productivity, protect our environment through better resource management, and generate data with confidence. In addition, its seamless communication with the Agilent 5977A Series GC/MSD provides faster vent times and system protections when using hydrogen carrier gas.



The Agilent 7890B GC adds integrated “smart” functionality and improved performance to the industry-leading GC platform.

Proven reliability and high performance

Agilent's 5th-generation electronic pneumatics control (EPC) and digital electronics are now complemented by improved detector specifications, making the 7890B Agilent's most dependable – and highest-performing – GC ever.

Increased sample throughput

Fast oven cool-down, new backflush capabilities, and advanced automation features help you get more done in less time, at the lowest possible cost per sample. All can easily be incorporated into your existing method.

Integrated system intelligence

Early Maintenance Feedback (EMF) allows you to replace parts quickly, and address small problems *before* they lead to costly downtime. Built-in calculators and method translator are also integrated into the data system software to simplify method setup and system operation.

What's more, the improved GC↔MSD communication cuts venting time by up to 40%, and protects the system from damage by stopping the flow of carrier gas during shutdown events.

Expanded chromatographic capabilities

Backflush, flow splitters, GCxGC, Dean's switches, and purged unions are all provided by Agilent Capillary Flow Technology (CFT).



Eco-friendly operation

Sleep mode reduces power and gas consumption during periods of inactivity, while **Wake mode** readies the system for high-throughput operation. You can also switch to lower-cost gases while in standby mode. **Page 12**

Leading-edge technologies increase analytical capabilities and reliability



Faster, more intuitive software

New Agilent OpenLAB CDS is 40 times faster. Added tools and wizards help turn results into answers. **Page 11**



End-to-end protection for active compounds

Agilent now applies our proprietary deactivation technologies to our new Split/Splitless inlet option, Ultra Inert liners, gold seals, columns, and improved detectors. **Page 4**



Enhanced inlet and detector modules

Numerous module enhancements let you customize your GC system in minutes.

Pages 8, 17, 21



New integrated system maintenance and Parts Finder tools

Reduce downtime and operating costs with simplified maintenance and status monitoring. Find consumables and replacement parts faster with a 3D graphical tool. **Pages 11, 13**

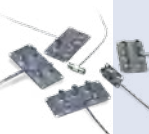

Enhanced Capillary Flow Technology

Enable leak-free, in-oven connections while improving throughput and reliability. An easy setup wizard gets you up and running quickly.

Page 6



Wide choice of system components

Configure and automate your system to increase efficiency and productivity – and expand your analytical capabilities. **Pages 14, 21**



Reduce dependency on helium

Integrated calculators help you convert helium methods to more available – and less expensive – gases like hydrogen or nitrogen. **Page 5**

ENSURE RELIABLE, CONSISTENT INERTNESS

Actionable concentrations continue to decrease as new, relevant compounds are increasingly active. By ensuring reliable, consistent inertness from injector to detector, the Agilent Inert Flow Path decreases analyte adsorption for lower Limits of Detection (LOD) and better signal-to-noise response.

An integrated approach to inertness

Using an Agilent Inert Flow Path ensures the inertness of every surface that touches your sample, so you can achieve the parts-per-billion – or parts-per-trillion – detection levels that today's analyses demand.

- **Agilent J&W Ultra Inert GC columns** are tested with the industry's toughest test probe mixture to ensure consistent column inertness and exceptionally low column bleed.
- **Ultra Inert liners** deliver a robust, reproducible, and reliable inert flow path – with or without glass wool.
- **Inert Flow Path Split/Splitless inlet option** provides an extra measure of inertness to the sample pathway.
- **Ultra Inert gold seals** feature deactivation chemistry applied *on top* of their gold plating for the most inert surface and highest-quality seal.
- **UltiMetal Plus Flexible Metal ferrules** are compatible with Capillary Flow Technology fittings, promoting a leak-free seal that requires less torque – and reduces the risk of column breakage.
- **Gas Clean filter systems** deliver the cleanest possible gas, reducing column damage, sensitivity loss, and downtime.
- **GC detectors** allow the selectivity or sensitivity that your application requires – and the ability to handle your data with a unified platform.

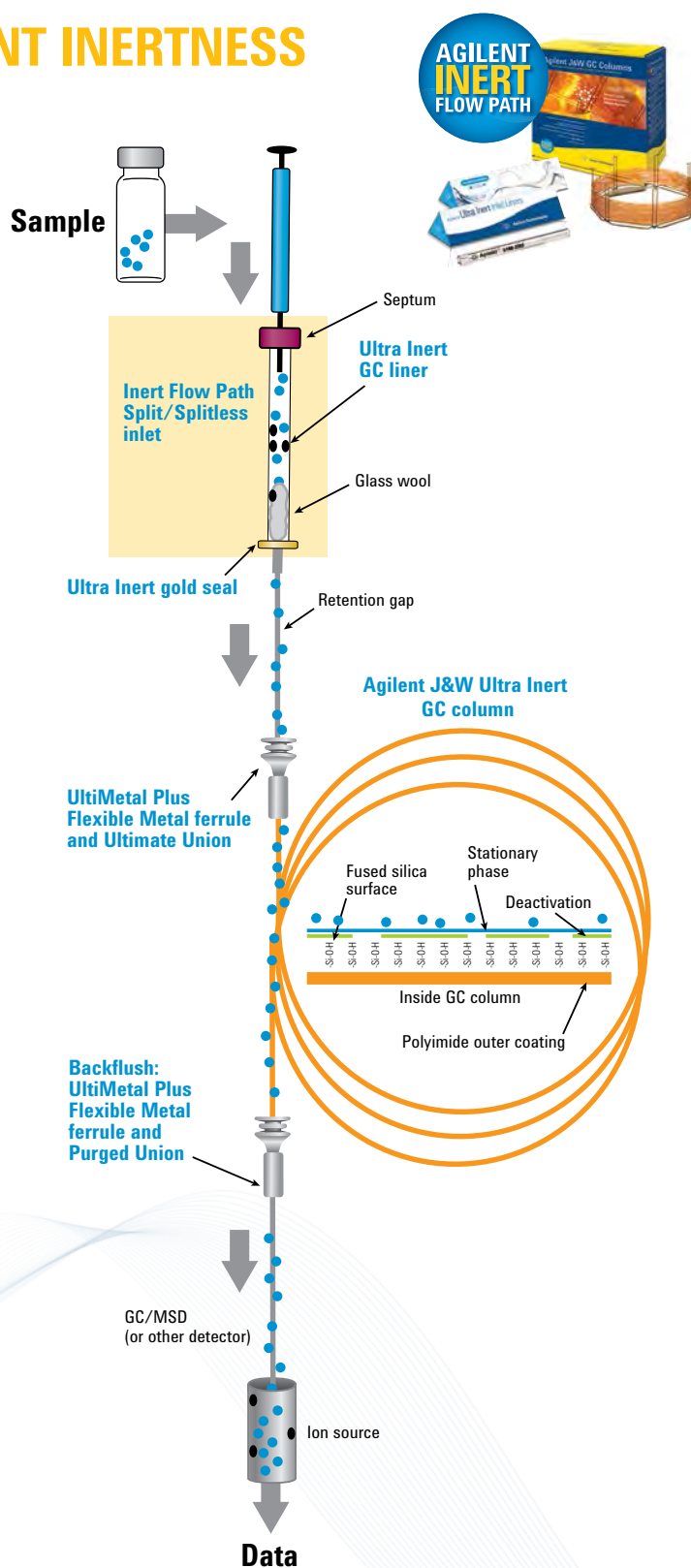

For more information about creating an inert GC flow path, visit [agilent.com/chem/inert](https://www.agilent.com/chem/inert)

CARRIER GAS OPTIONS

USE RESOURCES EFFICIENTLY

Alternate carrier gases minimize the impact of the helium shortage

In response to the global shortage of analytical-grade helium, many labs are switching to alternate carrier gases – such as nitrogen and hydrogen.

Nitrogen is a good choice when there is sufficient chromatographic resolution. Hydrogen has excellent chromatographic qualities and can increase throughput. The Agilent Hydrogen Sensor can detect potential leaks early to bring your system to a safe stand-by if necessary.

Helium conservation for validated methods

Agilent's helium conservation module, helium switch, and other tools allow you to use helium for your GC runs, and switch to an alternate gas (such as nitrogen) when your GC is idle. That means you can dramatically decrease helium usage without changing your validated methods.

Precise Retention Time Locking (RTL) software

RTL reproduces retention times from one Agilent GC system to another, regardless of inlet, detector, operator, or location for confident methods transfer worldwide.

Agilent's 5th generation EPC and digital electronics further improve RTL precision for low-pressure applications.

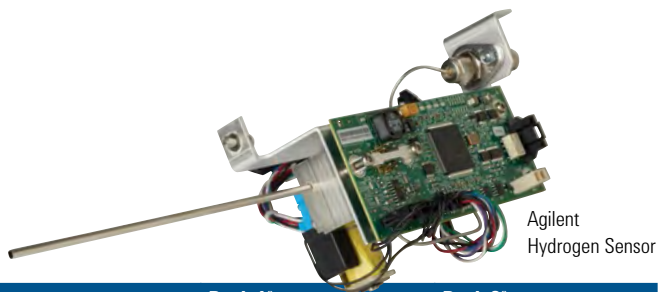

Run	Peak 1*	Peak 2*
1	9.0839 min	11.8492 min
2	9.0835	11.8492
3	9.0841	11.8494
4	9.0846	11.8496
5	9.0851	11.8507
6	9.0849	11.8502
7	9.0845	11.8504
8	9.0849	11.8500
9	9.0847	11.8504
10	9.0853	11.8502
11	9.0852	11.8502
12	9.0851	11.8508
13	9.0847	11.8503
14	9.0848	11.8507
15	9.0853	11.8506
Average	9.0847 min	11.8501 min
Standard Deviation	0.000527	0.000535

*Heart-cut from column 1. Demonstrating retention time reproducibility.

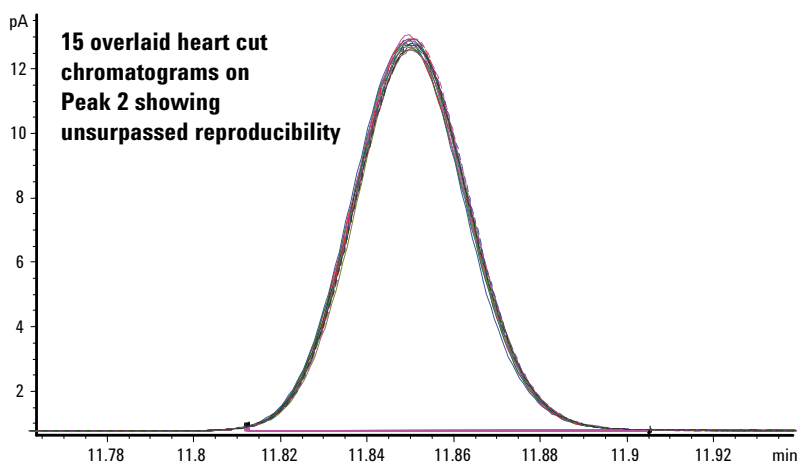

Achieve unsurpassed retention time reproducibility in standard applications – even with multi-dimensional applications, such as the heart-cutting example shown here.

To learn more about the Agilent 7890B GC, visit agilent.com/chem/7890B

CAPILLARY FLOW TECHNOLOGY

INCREASE FLEXIBILITY AND THROUGHPUT

Agilent's proprietary Capillary Flow Technology (CFT) solves a problem chromatographers have been wrestling with for decades: creating leak-free capillary connections that can withstand the temperature extremes of a modern GC oven.

CFT devices are inert, with low mass and low dead volume to help you make secure connections and precisely divert your gas flow pneumatically. This opens the door to techniques that can expand analytical capabilities, improve your results, and conserve both time and resources.

CFT backflush saves you time with every run

Backflushing works by reversing the column flow immediately after the last compound of interest has eluted, thereby sweeping material backwards through the column and out the split vent.

This simple technique extends column life and eliminates long bake-out times for highly retained sample components. It also prevents problems such as carryover, retention time shifts, and MSD source contamination.

Backflush Assistant Software Wizard simplifies method set-up

The Backflush Assistant Software Wizard first collects information about your method and CFT device, then provides a step-by-step procedure for configuring the backflush hardware and column plumbing. Once the backflush-enabled method and timing are determined, a validation protocol confirms that the method performs properly and robustly.

Expert training: just a phone call away

Backflush and Backflush Assistant Software Wizard training from Agilent Workflow Services can help you set up your CFT Backflush method quickly and efficiently.

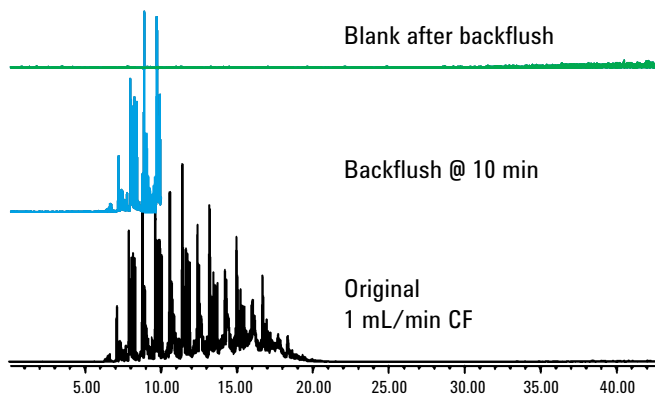

5989-9804EN: Capillary Flow Technology: Backflush – Reduce Run Time and Increase Laboratory Throughput

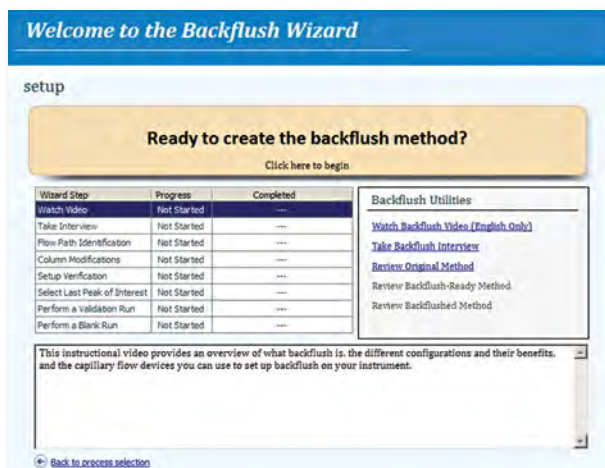

Backflush Wizard simplifies method development and set-up.

DEANS SWITCH AND FLOW SPLITTERS

ENHANCE CHROMATOGRAPHIC CAPABILITIES

A Capillary Flow Technology (CFT) Deans Switch, using fluidic switching, allows precise, 2-dimensional GC heart-cutting analysis of trace compounds in complex matrices.

Deans Switch improves selectivity for trace compounds in complex matrices

Peaks of interest from one column are “cut” onto a second column with a different stationary phase. Compounds that might co-elute with analyte on the first column are separated from analyte on the second column.

Flow splitting delivers more information per injection

Flow splitting – sending the sample to multiple detectors – maximizes the data collected in a single run, and is useful for analyzing compounds in complex matrices. This technique can also help you identify peaks of interest quickly, improve peak integration, and identify unknowns.

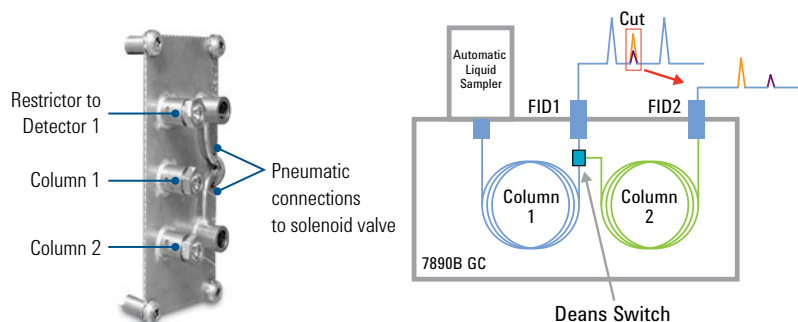

In this example, the Capillary Flow Deans Switch enabled unresolved trace components to be heart-cut onto a second column with a different stationary phase.

5989-9384EN: Capillary Flow Technology: Deans Switch – Increase the Resolving Power of Your GC

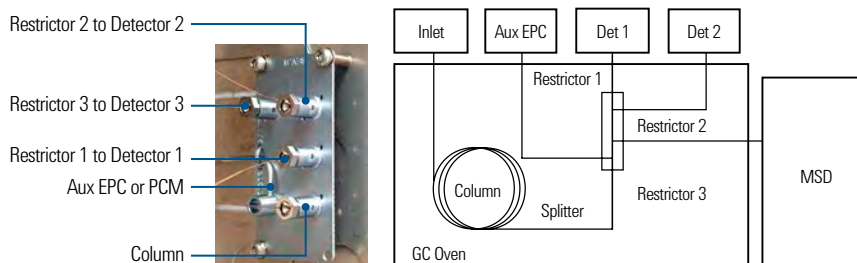

Agilent CFT devices provide easy-to-make, reliable connections for better chromatography.

5989-9667EN: Capillary Flow Technology: Splitters – Get More Information in Less Time

Strawberry extract highlighting unknowns

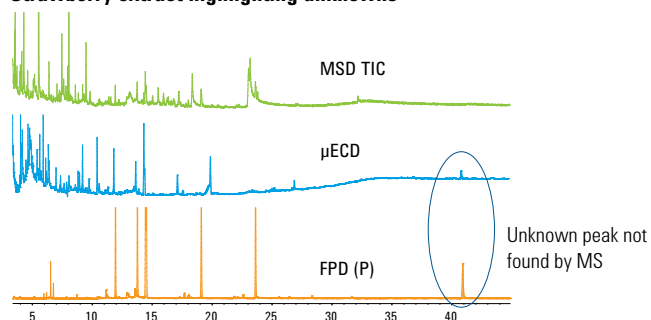

TIP: Agilent UltiMetal Plus Flexible Metal ferrules improve the reliability of your GC column connections. Learn more at agilent.com/chem/flexiferrule



To learn more about the Agilent 7890B GC, visit agilent.com/chem/7890B

INLETS, DETECTORS, AND LTM TECHNOLOGY

KEEP YOUR LAB RUNNING AT PEAK PERFORMANCE – NOW, AND IN THE FUTURE

The modular Agilent 7890B GC system lets you choose from the industry's widest selection of inlets, detectors, columns, and automated sample introduction techniques. Entire injector and detector modules can be changed in minutes, while injector and detector components can be swapped independently of pneumatics and electronics – saving your lab time and money.

Multimode Inlet (MMI) for flexibility and sensitivity

Agilent's MMI combines spit/splitless operation, temperature programming, and large-volume injection with a solvent vent mode. Benefits include higher sensitivity, robust handling of dirty samples, and the ability to analyze thermally labile compounds.

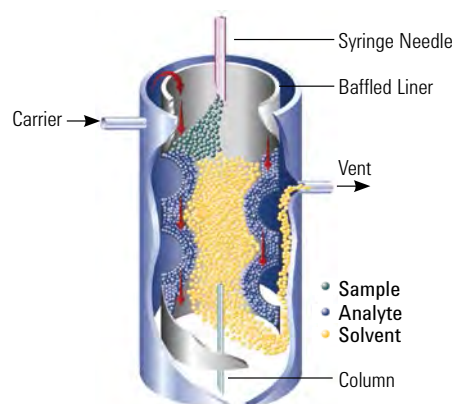

5990-3954EN: Agilent Multimode Inlet for Gas Chromatography

Full dynamic range FID

Our state-of-the-art digital electrometer delivers a linear dynamic range of 10^7 , seamlessly integrated into a single run.

Sensitive and selective element detection

Agilent's Flame Photometric Detector (FPD) is highly sensitive, with a temperature range of up to 400 °C. For demanding applications, Sulfur Chemiluminescence Detectors (SCD) and Nitrogen Chemiluminescence Detectors (NCD) provide the highest sensitivity and selectivity.

Low Thermal Mass (LTM) technology for more injections per hour

LTM technology promotes rapid heating and cooling for faster GC analyses, higher throughput, and less power consumption. With its independent temperature control of up to four column modules, LTM technology also enables multidimensional GC and integration with Capillary Flow Technology for reduced column maintenance. To simplify method transfer, most Agilent J&W GC columns are available for LTM modules.

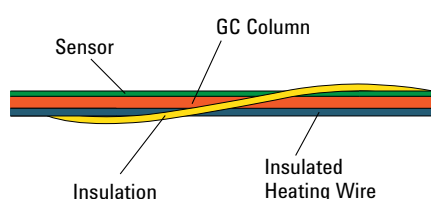

The key to LTM technology: weaving direct heating and temperature-sensing components around a standard fused-silica capillary column.

5990-7688EN: Agilent Low Thermal Mass (LTM) Series II System for Gas Chromatography

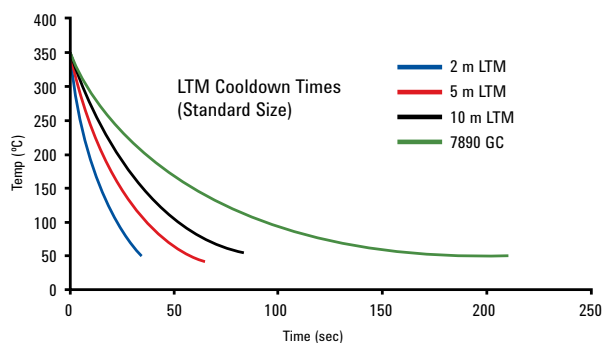

Typical cooling times for standard (5-inch) LTM column modules are significantly faster than a conventional GC oven.

5990-3237EN: Dual Channel Simulated Distillation of Carbon and Sulfur with the Agilent 7890A GC and 355 Sulfur Chemiluminescence Detector

EXTERNAL VALVE OVEN

CONFIGURATIONS EXPAND YOUR GAS SAMPLING OPTIONS

The Agilent Large Valve Oven (LVO) for GC is a versatile, high capacity external oven, which can be configured to support complex, multi-valve GC applications. The LVO supports several standard Agilent multi-valve analyzers such as RGA and NGA, but is also available as a highly customizable option on the 7890B GC. Precisely engineered for thermal isolation from the GC oven, the LVO provides a homogeneous isothermal environment for up to six valves and convenient open-access for maintenance, adjustment or customization. Accessibility, capacity, and thermal uniformity make the Agilent LVO a premium GC valving option, especially suited to support the rising trend of combining multiple complex analyses on a single GC platform.

Other advantages include:

- Open configuration, which allows easy maintenance and servicing – while maintaining the standard 7890B GC system footprint.
- The ability to configure analyzers, such as RGA, that require multiple thermal zones.
- Six valve positions, with a maximum 14-port valve, so you can configure the system to meet your application requirement.
- Use only one heated GC zone with optional valve configurations to meet your current and future testing needs.

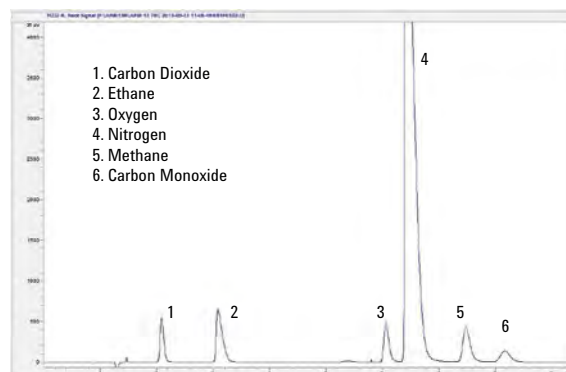
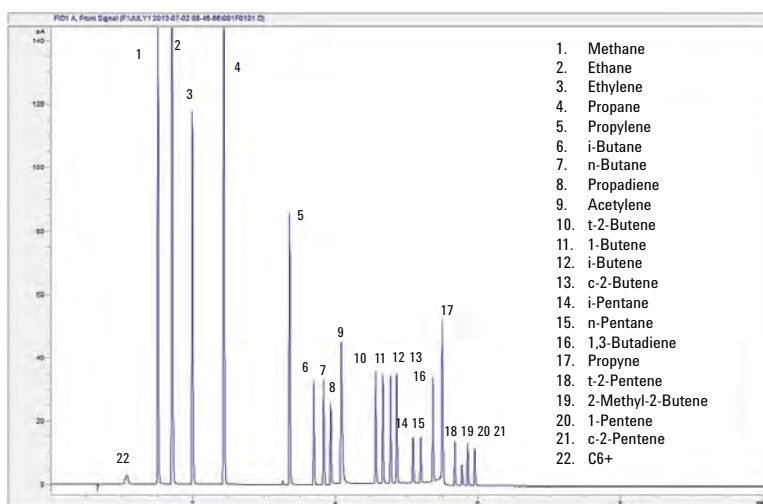

Results of the fast analysis time possible with the RGA method. In this example, the new Large Valve Oven is setup and running as the RGA analyzer, which is preconfigured and provides guaranteed chromatographic performance.

To learn more about the Agilent 7890B GC, visit agilent.com/chem/7890B

SIMPLIFY OPERATIONS AND BOOST PRODUCTIVITY

Integrated method development tools and calculators take the guesswork out of tasks such as changing carrier gas, selecting the right liner, or changing to a column of different dimensions.

Interactive graphical consumables and Parts Finder tool quickly locates key parts on the GC system, and provides part numbers and descriptions for easy ordering.

Consumables database simplifies method development by minimizing tracking errors and automatically populating analytical methods with key configuration information.

Resource conservation tools, such as automatic sleep and wake modes, reduce gas and power consumption, while making sure the system is ready to run when you need it.

GC/MS MassHunter with MSD ChemStation Data Analysis: Agilent's newest platform designed to resolve your search for data

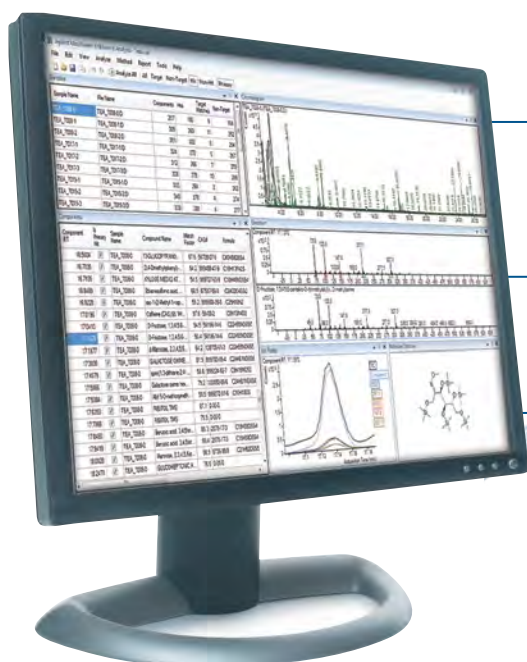

Quickly and confidently find the answers you seek for routine quantitation and more challenging discovery applications.

Choose either MassHunter or MSD ChemStation Data Analysis – the traditional choice for GC/MS analysis.

Common instrument control for Agilent GC/MS systems simplify your laboratory operation.



Agilent's Barcode Printing Bundle (G9201AA) has everything you need to print labels for the 7693 ALS and 7697A Headspace Samplers.



OpenLAB

CAPTURE • ANALYZE • SHARE

Make your lab more productive with OpenLAB CDS

OpenLAB CDS software makes your lab more efficient by reducing the time spent on data processing, review, and reporting. With OpenLAB CDS you can:

- Create reports using powerful and intuitive “drag-and-drop” capabilities.
- Process large data sets up to 40 times faster and review results quickly with powerful data analysis tools.
- Completely control your Agilent 7890B GC – including Parts Finder, Sleep/Wake, and Retention Time Locking.
- Accelerate and preserve your workflows – whether they are interactive or automated.
- Streamline the management of user privileges and password protection.
- Scale from a single instrument to a lab-wide network that centralizes system administration while allowing you to work from anywhere.

Secure centralized data storage is available through Agilent OpenLAB Data Store and OpenLAB ECM software, both of which integrate seamlessly with OpenLAB CDS.

Scalable architecture expands from a single instrument to lab-wide implementation.

Advanced data analysis and reporting drives greater throughput and productivity.



A trusted upgrade path preserves your investment in workflows, data, and methods.

Networked OpenLAB CDS allows you to get your work done from anywhere in the lab – and simplifies the administration of methods, user roles, and permissions.

To learn more about the Agilent 7890B GC, visit agilent.com/chem/7890B

RESOLVE YOUR SEARCH FOR INTEGRATION

SMART FEATURES TAKE SUPPORTABILITY, PERFORMANCE, AND SAFETY TO NEW HEIGHTS

INTEGRATED GC↔MSD COMMUNICATION AND SAFETY CONTROLS

Direct communication between the 7890B GC and 5977A Series GC/MSD enhances and protects your investment:

- If the MSD vents... the system increases the flow of carrier gas, shortening vent times by up to 40%.
- If the pump fails... the system shuts off the carrier gas, saving expensive helium or avoiding hydrogen build-up.
- If communications are lost... the system shuts down the GC thermal zones.



ECO-FRIENDLY

- Can also be used with hydrogen or nitrogen carrier gas to reduce operating costs
- Sleep/wake modes reduce gas and energy consumption.
- Helium Conservation Switch to move from helium when the system is not in use

PARTS INFORMATION AT YOUR FINGERTIPS

- Easily locate part numbers for consumables and supplies with **Parts Finder**, an interactive 3D graphical tool.
- Instantly see parts and consumables specific to your instrument configuration. You can then print or email purchase orders, or import directly into your agilent.com cart.
- Keep track of columns and supplies with an optional barcode reader, and auto-import accurate configuration information into your GC and analytical method.
- Parts ID tool quickly identifies parts and part numbers for easy re-ordering.



OPTIMIZE PRODUCTIVITY

- Early-maintenance feedback allows you to plan routine maintenance tasks and reduce unnecessary downtime.
- Agilent Data Systems easily develop and optimize methods through:
 - Integrated GC Calculators, including method translator and vapor volume calculator.
 - Auto transfer of calculated values to the method editor.
 - Setup and status of maintenance tracking counters.

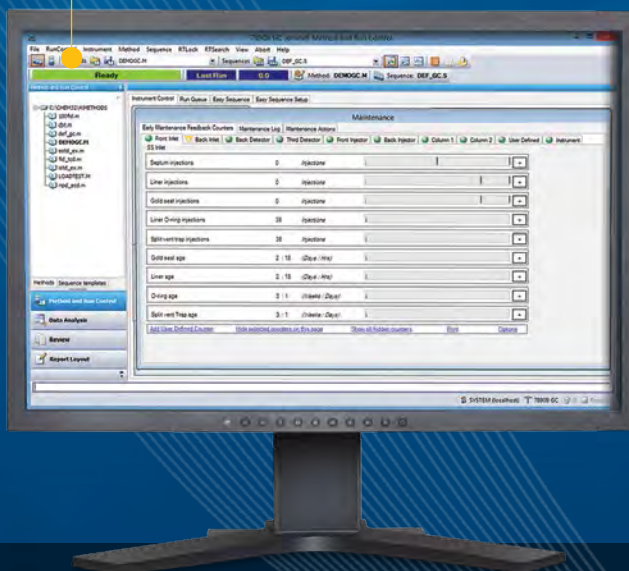
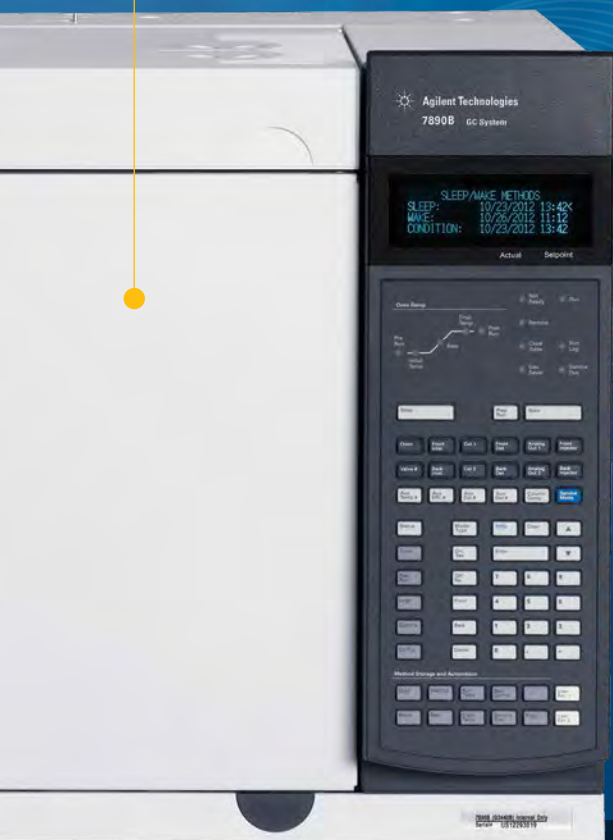

To learn more about the Agilent 7890B GC, visit agilent.com/chem/7890B

AGILENT AUTOSAMPLERS

THE PERFECT FIT FOR YOUR 7890B GC

The Agilent 7693 Series Automatic Liquid Sampler (ALS) delivers the fastest injection times of any GC autosampler. In addition, our 7693A platform offers a 16- or 150-vial capacity for reproducibility with small sample loads and high sample throughput, if needed. Enhanced capabilities – such as automated dilution, internal standard addition, heating, mixing, and solvent addition – help eliminate variability and rework.

If your lab processes fewer than 50 samples per day, the Agilent 7650A ALS is a robust, lower-cost option for optimizing workflows and maximizing sample throughput.

Boost your lab's output with advanced sample preparation capabilities

The Agilent PAL Autosampler is ideal for liquid injection, headspace, and solid-phase microextraction (SPME) applications. Although this versatile platform can be configured solely for liquid injection, it also offers many capabilities – including large-volume injection (LVI), multiple vial sizes, and extended sample vial capacity.

Automatically introduce volatile compounds from virtually any sample matrix

Agilent's 7697A Headspace Sampler ensures an inert sample pathway for superior GC system performance without analyte degradation or loss. Electronic Pneumatics Control (EPC), a 111-vial capacity, and three exchangeable 36-vial racks make the 7697A an ideal choice for high-throughput labs. In addition, the Agilent 7697A Headspace Sampler is the industry's only dedicated headspace unit that supports the use of hydrogen as a carrier gas.



Agilent 7693 Series ALS



Agilent PAL Autosampler



7697A Headspace Sampler

Protect your instrument – and the integrity of your samples – with Agilent's industry-leading vials, caps, and syringes

- ✓ Optimize your productivity
- ✓ Extend the life of your system
- ✓ Maximize your uptime



View the Agilent Sample Introduction brochure at agilent.com/chem/library and search for 5991-1287EN.

PHARMACEUTICAL APPLICATIONS

CONFIDENTLY DETECT IMPURITIES AT VERY LOW LEVELS

Gas chromatography, coupled with static headspace sampling, is an easy-to-use, high-throughput tool for determining residual solvent impurities in pharmaceutical products. Sample preparation is simple, and the method is easily validated. In addition, headspace sampling allows you to avoid matrix injections that can cause column degradation and coelution.

Residual solvent analysis using an Agilent 7890B GC system with an Agilent 7697A Headspace Sampler

Excellent chromatographic performance was achieved for residual solvents at USP <467> specified limits, as shown in this example for Procedure A - Class 1 Solvents.

This instrument configuration is available as an analyzer with guaranteed chromatographic performance.

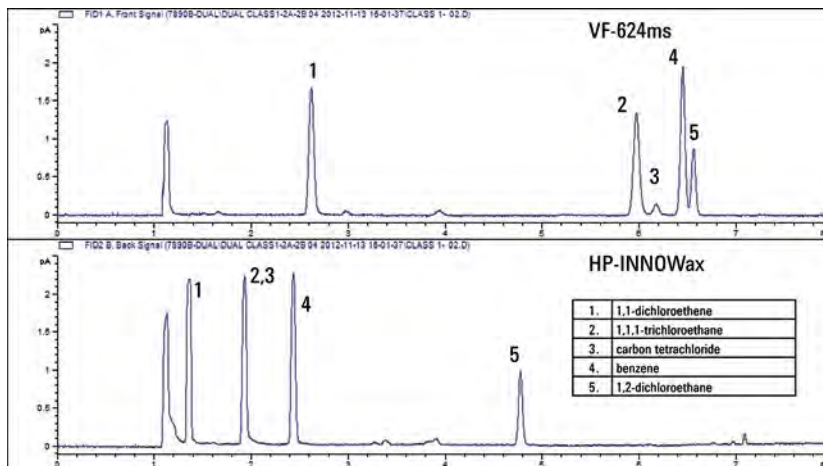

Excellent chromatographic performance is achieved on the Agilent 7890 Series GC. Equivalent data will be produced on a 7890A and 7890B system.

5991-1834EN: Analysis of USP <467> Residual Solvents using the 7697A Headspace Sampler with the 7890B Gas Chromatograph

Save energy, simplify maintenance, and conserve resources

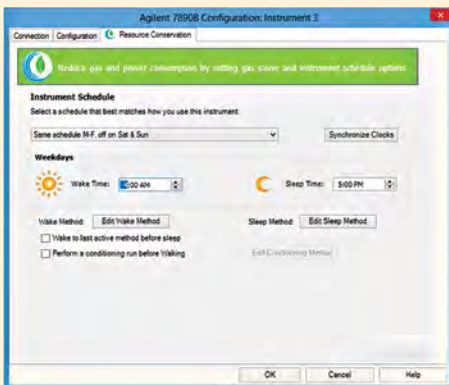

Sleep/wake mode lets you put your system to sleep when not in use, and have it awoken exactly when you need it.

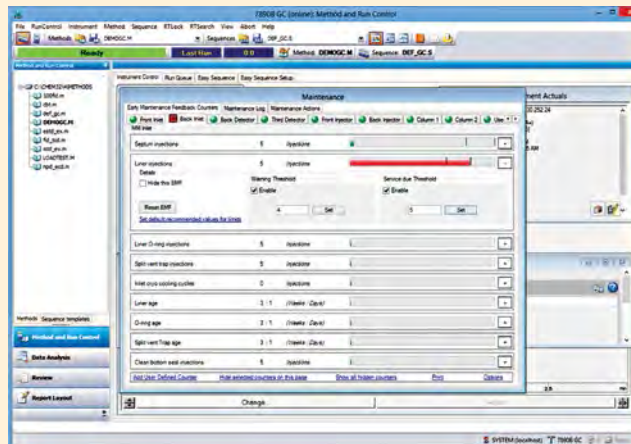

Early maintenance feedback (EMF) keeps track of injections and consumable usage, so you can establish maintenance SOPs.

To learn more about the Agilent 7890B GC, visit agilent.com/chem/7890B

TAKE YOUR LAB TO A HIGHER LEVEL OF RELIABILITY AND PRODUCTIVITY

If your lab still uses an “old workhorse” GC just because it gives you “acceptable results,” perhaps it’s time to consider the transformative advantages of Agilent’s 7890B GC. It goes beyond “acceptable results” to give you increased productivity, safety, cost effectiveness, and environmental friendliness – all with greater precision and reliability than instruments past their prime. Applied analyzers are also available, which provide methods and guaranteed chromatographic performance.

Technology innovations expand your range of analyses

- LTM technology reduces cycle time for Simulated Distillation.
- External Valve Oven enables rapid RGA with H₂S and O₂ separation.
- Pre-configured hardware and method-specific separation tools let you focus on calibration and validation per your lab’s SOPs.

Factory-configured analyzers let you start your analysis immediately after installation

All preconfigured analyzers provide the ability to install the new system and begin validation. There is no need to waste time developing methods, the method is factory proven. As a result, the time from installation to running samples is greatly reduced.

Fast simulated distillation using Low Thermal Mass module (LTM)

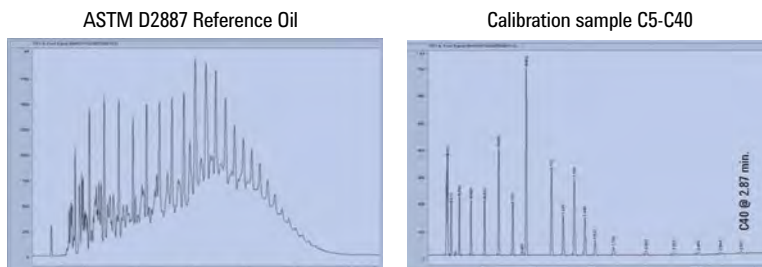

The simulated distillation results for ASTM D2887 RGO agree with the RGO specification of ASTM D2887, with RSDs of 0.12 to 0.47 percent across the reported range.

5990-3174EN: Fast Hydrocarbon and Sulfur Simulated Distillation Using the Agilent Low Thermal Mass (LTM) System on the 7890 GC and 355 Sulfur Chemiluminescence Detector

Fast RGA analysis

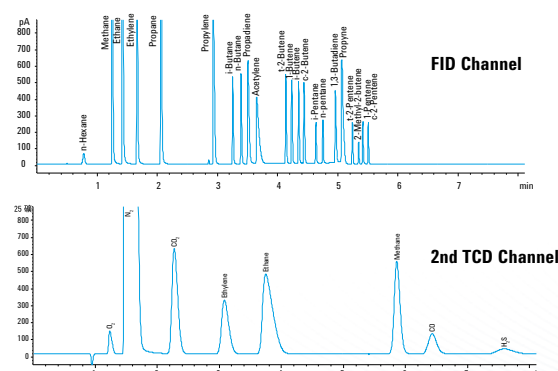

Oxygenates in finished gasoline per ASTM D4815

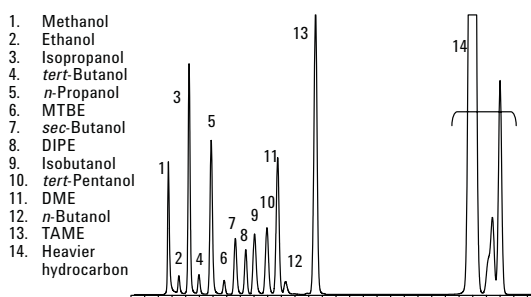

5991-1561EN: Analyzer Solution Guide for Energy & Chemicals Industry

Conform to industry requirements for sulfur levels

Sulfur distribution in feedstocks is critical to the refining industry as it adjusts to meet clean fuel requirements. Agilent's new Flame Photometric Detector, with its high temperature capability and improved sensitivity, is an ideal tool for determining sulfur in blending stocks, such as light cycle oil (LCO). Profiling dibenzothiophenes is particularly important for achieving the lowest sulfur levels in the final products.

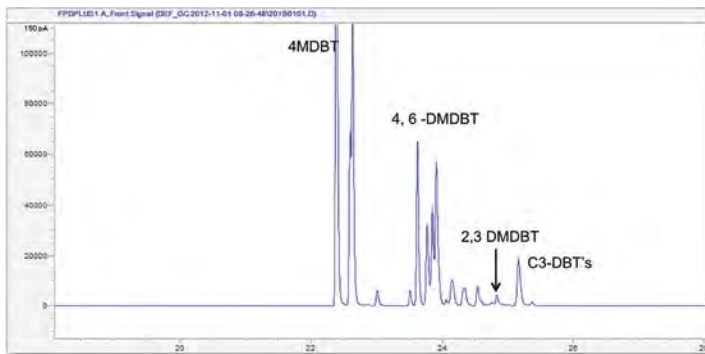

Analysis of substituted dibenzothiophenes in light cycle oil (LCO) using a CFT Deans Switch system with an Agilent 7890B FPD. This enhanced separation reduces the possibility for quenching caused by co-elution with hydrocarbons.

5991-1752EN: An Improved Flame Photometric Detector For the Analysis of Alkyldibenzothiophenes in Light Cycle Oil, and Gas Oil Feedstocks using the 7890B

Reliable trace sulfur analysis. Excellent reproducibility was achieved by coupling the Agilent 7890B GC with our sensitive, high-temperature FPD.



Flow modulation for comprehensive GC (GCxGC)

The Agilent 7890B GC uses Capillary Flow Technology to enable flow modulation without the need for complicated – and costly – cryo-focusing techniques. This analysis of diesel fuel shows the normal boiling point distribution in the first dimension, and functional group clusters in the second dimension.

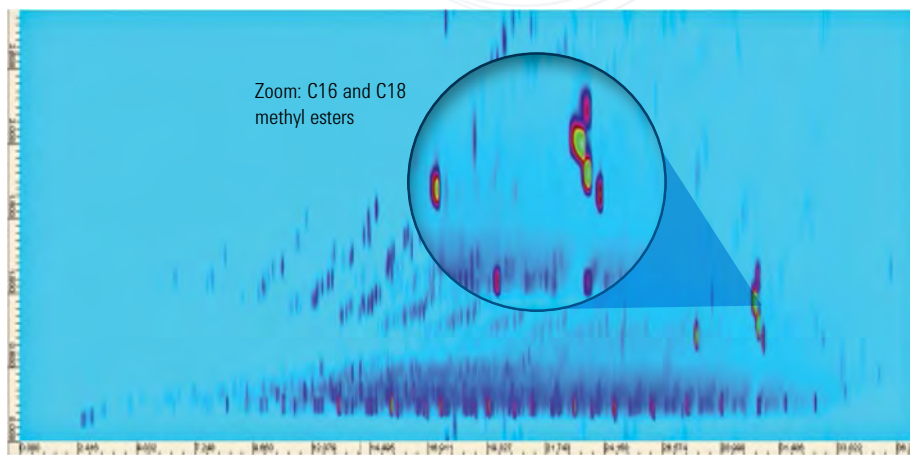

GCxGC of a B20 biodiesel showing separation of C16 and C18 methyl esters. Modulation period: 2800 seconds. Column 1: 20 m x 0.18 mm, 0.18 μ m DB1, Column 2: 4 m x 0.24 mm, 0.25 μ m HP-INNOWax.

5989-9889EN: Capillary Flow Technology: GCxGC Flow Modulator: Get a Second Dimension of Information on Complex Mixtures

To learn more about the Agilent 7890B GC, visit agilent.com/chem/7890B

ENVIRONMENTAL APPLICATIONS

ACCELERATE SCREENING METHODS

US EPA Method 8270 is widely used to determine the concentration of semi-volatile organic compounds in environmental matrices – many of which contain a mix of acids, bases, and neutrals. This method can be challenging without an Agilent Inert Flow Path due to interactions between analytes and flow path surfaces.

Backflush improves cycle time for semi-volatiles analysis

Here, a 5 ppm EPA 8270 standard run was spiked into 5000 ppm of heavy oil to simulate interference from hazardous waste.

During the first run, peaks of interest eluted in less than 16 minutes, but an additional 24-minute bake-out at 320 °C was required to elute components with high boiling points. The sample was rerun with a 4-minute backflush, which cut the cycle time by 20 minutes per run – a 50% total cycle time savings. Autosampler overlap functionality and faster cool down saved an additional 4 minutes per cycle – that’s an additional 15 samples that can be run every 12 hours.

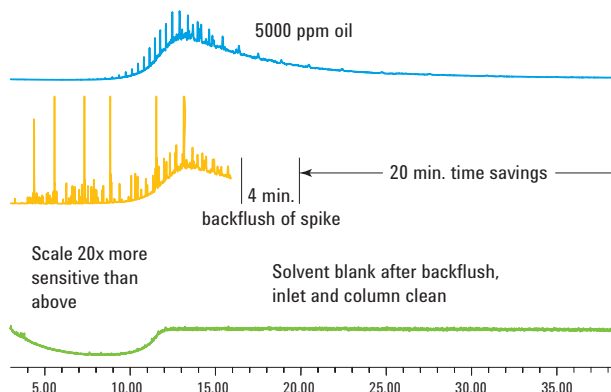

5989-6026EN: Significant Cycle Time Reduction Using the Agilent 7890/5975 GC/MSD for EPA Method 8270

LTM technology accelerates analysis of TPH (Mineral Oil)

Fast oven temperature programming using a low-thermal-mass system reduces cycle time and increases sensitivity for GC-FID analysis of mineral oil in environmental samples.

This technique meets regulated method requirements for analyzing the C10-C40 hydrocarbon fraction in soil and water extracts using splitless injection. The total analytical cycle time was *less than five minutes*.

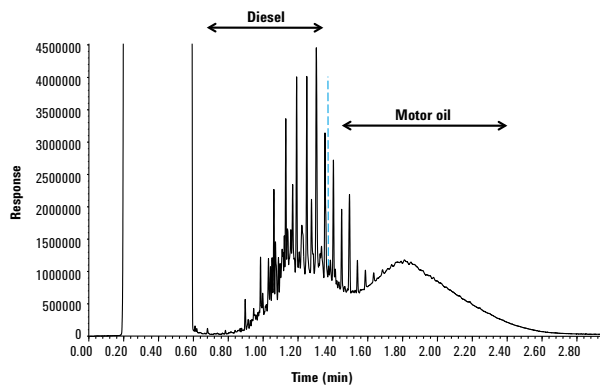

5990-9104EN: High Throughput Mineral Oil Analysis (Hydrocarbon Oil Index) by GC-FID using the Agilent Low Thermal Mass (LTM II) System



Method Calculator makes it easy to set up a method that shortens analysis time or facilitates the changing of carrier gas.

CONFIDENTLY EXECUTE YOUR MOST SPECIALIZED ANALYSES

Lower detection limits with the Agilent Multimode Inlet (MMI)

Agilent's MMI has the same form factor and uses the same consumables as our split/splitless inlet, so you can replicate your existing hot splitless methods. Its temperature programmability also lets you perform both cold splitless and large-volume injection (LVI) methods for improved detection limits. An integrated Solvent Elimination Calculator also provides a complete set of initial conditions for easy LVI method development.

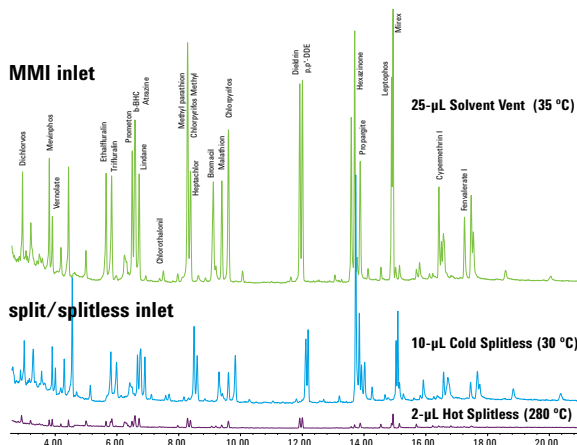

Total ion chromatogram comparing a 25- μ L solvent vent injection with a 2- μ L hot splitless injection for 40-ppb pesticides. Note the significant signal-to-noise improvement (lower detection limits).

5990-4169EN: Achieving Lower Detection Limits Easily with the Agilent Multimode Inlet (MMI)

Pesticides in milk extract: Flow splitting enables multiple detectors – increasing productivity

Agilent's flow splitting device proportionally splits column effluent to multiple detectors. Full-scan TIC from the MSD provides quantitation and confirmation, while element-specific GC signals highlight trace-level compounds for MSD identification.

The splitter also provides backflush capabilities to shorten cycle time and increase column life. Backflushing reduces ion source contamination by preventing column bleed and stopping heavy residues from being introduced into the MSD. It also eliminates carryover from any sample that accumulates at the column head, improving data integrity.

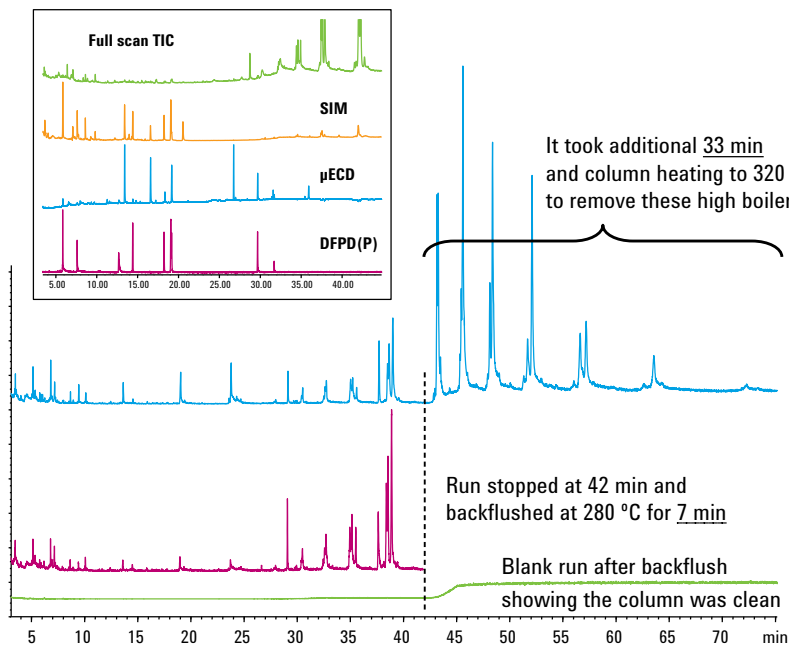

It took additional **33 min** and column heating to 320 °C to remove these high boilers.

Run stopped at 42 min and backflushed at 280 °C for **7 min**

Blank run after backflush showing the column was clean

Four chromatograms collected simultaneously from a single injection of milk extract.

5989-6018EN: Improving Productivity and Extending Column Life with Backflush

To learn more about the Agilent 7890B GC, visit agilent.com/chem/7890B

SCREEN AND QUANTITATE TARGET COMPOUNDS IN COMPLEX MATRICES

Rapid drug screening: Obtain more information in less time

An Agilent Capillary Flow device splits column eluent, allowing the simultaneous acquisition of NPD and MSD data – and eliminating the need for multiple runs on different GCs. CFT Backflush further reduces cycle time and stabilizes retention times.

GC/NPD/MSD with simultaneous SIM/Scan offers advantages such as broad-range screening for unlimited targets, full-spectrum identity confirmation, and non-target identification through Deconvolution Reporting Software (DRS) library searches.

This system collects Scan, SIM, and NPD data simultaneously. Scan is used to screen for 725 toxic compounds. SIM is used for selecting low-level targets. NPD is used for confirmation aid and highlighting suspicious non-targets.

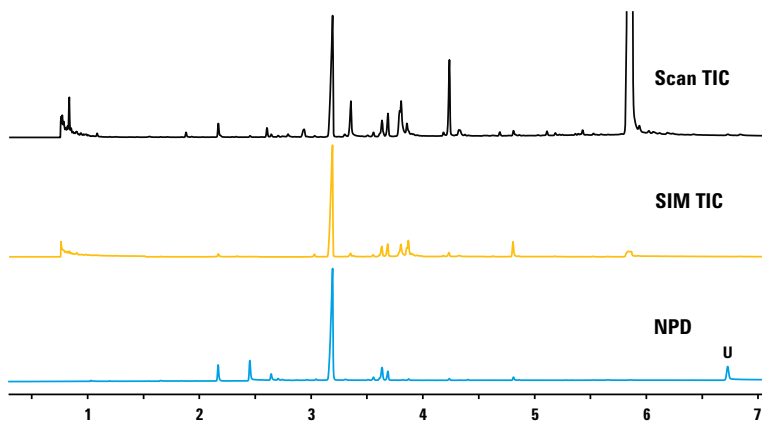

Toxicology screen on real blood extract.

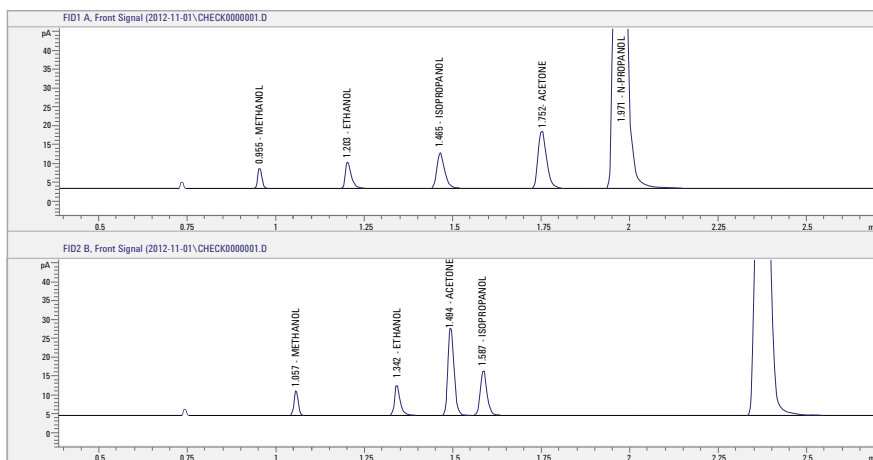

Ethanol and mixed volatile calibrator at 0.01% per component. N-propranol ISTD. The compounds elute at different retention times due to different column selectivities; therefore, two-channel analysis provides additional confirmation of accuracy.

EXPAND THE POSSIBILITIES OF SYSTEM CONFIGURATION

A wide inlet selection lets you optimize your system for *your* analysis

- Split/splitless (SSL) capillary
- Inert flow path split/splitless (ISSL) capillary
- Multimode inlet (MMI)
- Purged packed injection port (PIIP)
- Cool on-column (COC)
- Cool on-column with solvent vapor exit (COC-SVE)
- Programmable temperature vaporizing (PTV)
- Volatiles interface (VI)
- High-pressure gas sample injection
- Gas sampling valve (GSV)
- Liquid sampling valve (LSV)

High-sensitivity detectors accommodate every sample type

- Mass selective detector (MSD)
- Triple Quadrupole MS
- Q-TOF MS
- Ion Trap MS
- ICP-MS
- Flame ionization detector (FID)
- Thermal conductivity detector (TCD)
- Micro-electron capture detector (Micro ECD)
- Flame photometric, single- or dual-wavelength detector (FPD)
- Nitrogen-phosphorus detector (NPD)
- Sulfur chemiluminescence detector (SCD)
- Nitrogen chemiluminescence detector (NCD)
- Atomic emission detector (AED)*
- Pulsed flame photometric detector (PFPD)*
- Photoionization detector (PID)*
- Electrolytic conductivity detector (ELCD)*
- Halogen specific detector (XSD)*
- Oxygenate flame ionization detector (O-FID)*
- Pulsed discharge helium ionization detector (PDHID)*

* Available through Agilent Channel Partners. Contact Agilent for other custom configurations, and additional solutions available through Agilent Channel Partners



GC and GC/MS Analyzers let you focus on system validation and data generation... not method development

Agilent GC and GC/MS Analyzers are factory configured and chemically tested to meet method requirements, and get you on the "Fast Track" to producing quality data and processing sample backlogs. More than just instruments, Agilent Analyzers are complete workflow solutions that incorporate advanced technologies, such as Capillary Flow Technology and target compound databases that allow us to optimize your system for your unique application.

Each Analyzer arrives ready to perform with pre-set chromatography and checkout samples to verify separation capabilities. That means your team can work toward system validation as soon as installation is complete – and significantly reduce your method development costs. And as always, our support team is available, should any problems arise.

To learn more about the Agilent 7890B GC, visit agilent.com/chem/7890B

RELIABLY EXTRACT AND PREPARE SAMPLES FROM COMPLEX MATRICES



Simplify sample prep with pre-packaged Agilent Bond Elut QuEChERS Kits

- **Extraction kits** with pre-weighed salts in anhydrous packets allow you to add salts after you add organic solvent – avoiding exothermic reactions.
- **Dispersive kits** accommodate the aliquot volumes specified by current AOAC and EN methodologies.
- **Ceramic homogenizers** break up salt agglomerates, promoting consistent sample extraction and increasing recovery.

Produce cleaner extracts using Agilent Bond Elut SPE

- **A selection** of polymer, silica, and other sorbents in formats ranging from multiple cartridge sizes to 96-well plates.
- **Consistent particle size** ensures superior flow-through and performances.
- **Vacuum manifolds and accessories** help you meet all of your SPE challenges.

Make sample prep consistent, accurate, and safe with the Agilent 7696A Sample Prep WorkBench

Agilent's 7696A Sample Prep WorkBench combines precise automation with an intuitive software interface to eliminate variability in dilution, extraction, standards addition, and other key steps. It also significantly reduces exposure to hazardous solvents for long-term peace-of-mind.

All prepared samples are finished in 2 mL vials that are compatible with most GC and LC autosamplers for direct analysis without transferring to other sample containers.



AGILENT STANDS BEHIND EVERY INSTRUMENT



Compliance

With over 100,000 qualification deliveries, and decades of quality testing experience, Agilent is your trusted source for the system qualification and proof of calibration you need for regulatory compliance.



Agilent Value Promise

We guarantee you at least 10 years of instrument use from your date of purchase, or we will credit you with the residual value of the system toward an upgraded model.



Real-time support and reporting

Agilent Remote Advisor is a remote monitoring, diagnostic, and reporting feature now included in all Agilent Advantage service plans. It can help you preempt instrument problems to maximize your uptime and productivity.



Agilent Service Guarantee

If your Agilent instrument requires service while covered by an Agilent service agreement, we guarantee the repair, or we will replace your instrument for free.



Workflow Services

Capillary Flow Technology (CFT) Backflush and Backflush Assistant Software Wizard training are available through Agilent Workflow Services. Expert assistance in setting up your CFT backflush method is just a phone call away.



THE AGILENT 7890B GC SYSTEM

RESOLVE YOUR SEARCH FOR INTEGRATION, RELIABILITY, AND INTELLIGENCE

- **Powerful software tools** for data acquisition, analysis, and reporting help you get the most out of your instrument.
- **Integrated Parts Finder tool and database** makes it easy to find and order columns, supplies, and parts.
- **Inert GC Flow Path** ensures higher sensitivity, accuracy, and reproducibility – especially at trace levels.
- **Capillary Flow Technology (CFT)** enhances chromatographic capabilities.
- **Direct GC ↔ MSD communication** minimizes downtime while conserving power and gas.
- **Eco-friendly features**, such as sleep/wake modes, conserve electricity, helium, and other resources.
- **Early maintenance feedback** keeps the system performing at its best.
- **Fast oven cool-down**, new backflush capabilities, and advanced automation boost your productivity.

For more information

Learn more

agilent.com/chem/7890B

U.S. and Canada

1-800-227-9770

agilent_inquiries@agilent.com

Europe

info_agilent@agilent.com

Asia Pacific

inquiry_lsca@agilent.com

In other countries, please call your local Agilent Representative or Agilent Authorized Distributor – visit **agilent.com/chem/contactus**

This information subject to change without notice.

© Agilent Technologies, Inc. 2013
Printed in the USA December 24, 2013
5991-1836EN



Agilent Technologies